

## Zener Diode

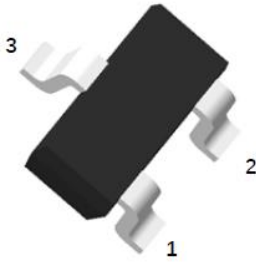
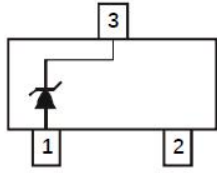

SOT-523

### Features

- Moisture sensitivity level 1
- Zener voltage 2.4V~39V

### Application

- Linear voltage regulator
- DC regulator
- Small-signal surge protection

### Mechanical data

- **Package:** SOT-523
- **Terminals:** Tin plated leads, solderable per J-STD-002 and JESD22-B102

### ■ Maximum Ratings (Ta=25°C Unless otherwise specified)

Characteristic	Symbol	Value	Units
Maximum Forward Voltage @I <sub>F</sub> =10mA	V <sub>F</sub>	0.9	V
Power Dissipation	P <sub>D</sub>	150	mW
Thermal Resistance	R <sub>thJA</sub>	833	°C/W
Operation Temperature	T <sub>J</sub>	-55~+150	°C
Storage Temperature Range	T <sub>STG</sub>	-55~+150	°C

### ■ Ordering Information (Example)

Preferred P/N	Packing Code	Unit Weight(G)	Minimum Package(Pcs)	Inner Box Quantity(Pcs)	Outer Carton Quantity(Pcs)	Delivery Mode
BZX84C2V4T THRU BZX84C39T	F2	Approximate 0.0027	3000	30000	120000	7" reel



# BZX84C2V4T THRU BZX84C39T

## ■Electrical Characteristics (Ta=25°C unless otherwise specified)

Type Number	Marking Code	V <sub>z</sub> @ I <sub>ZT</sub> (V)			Z <sub>ZT</sub> (Ω)		Z <sub>ZK</sub> (Ω)		I <sub>R</sub> (μA) @V <sub>R</sub>		Typical temperature coefficient @ I <sub>ZTC</sub> mV/°C		Test Current I <sub>ZTC</sub>	Diode capacitance Cd (pF)	Non-repetitive peak reverse current I <sub>ZSM</sub> (A)
		min	typ	max	max	I <sub>ZT</sub> (mA)	max	I <sub>ZK</sub> (mA)	max	V <sub>R</sub> (V)	min	max	mA	max	max
BZX84C2V4T	RB	2.2	2.4	2.6	100	5	600	1	50	1	-3.5	0	5	450	6
BZX84C2V7T	RC	2.5	2.7	2.9	100	5	600	1	20	1	-3.5	0	5	450	6
BZX84C3V0T	RD	2.8	3.0	3.2	95	5	600	1	20	1	-3.5	0	5	450	6
BZX84C3V3T	RE	3.1	3.3	3.5	95	5	600	1	5	1	-3.5	0	5	450	6
BZX84C3V6T	RF	3.4	3.6	3.8	90	5	600	1	5	1	-3.5	0	5	450	4.5
BZX84C3V9T	RG	3.7	3.9	4.1	90	5	600	1	3	1	-3.5	0	5	450	4.5
BZX84C4V3T	RH	4.0	4.3	4.6	90	5	600	1	3	1	-3.5	0	5	450	3.5
BZX84C4V7T	R1	4.4	4.7	5.0	80	5	600	1	3	2	-3.5	0	5	300	3.5
BZX84C5V1T	R2	4.8	5.1	5.4	60	5	500	1	2	2	-2.7	1.2	5	300	3
BZX84C5V6T	R3	5.2	5.6	6.0	40	5	480	1	1	2	-2	2.5	5	200	3
BZX84C6V2T	R4	5.8	6.2	6.6	10	5	400	1	3	4	0.4	3.7	5	200	3
BZX84C6V8T	R5	6.4	6.8	7.2	15	5	150	1	2	4	1.2	4.5	5	200	2
BZX84C7V5T	R6	7.0	7.5	7.9	15	5	80	1	1	5	2.5	5.3	5	150	2
BZX84C8V2T	R7	7.7	8.2	8.7	15	5	80	1	0.7	5	3.2	6.2	5	150	2
BZX84C9V1T	R8	8.5	9.1	9.6	15	5	80	1	0.5	6	3.8	7.0	5	150	1.8
BZX84C10T	R9	9.4	10	10.6	20	5	100	1	0.2	7	4.5	8.0	5	90	1.8
BZX84C11T	P1	10.4	11	11.6	20	5	150	1	0.1	8	5.4	9.0	5	85	1.8
BZX84C12T	P2	11.4	12	12.7	25	5	150	1	0.1	8	6.0	10.0	5	85	1.8
BZX84C13T	P3	12.4	13	14.1	30	5	150	1	0.1	8	7.0	11.0	5	80	1
BZX84C15T	P4	13.8	15	15.6	30	5	170	1	0.1	10.5	9.2	13.0	5	75	1
BZX84C16T	P5	15.3	16	17.1	40	5	200	1	0.1	11.2	10.4	14.0	5	75	1
BZX84C18T	P6	16.8	18	19.1	45	5	200	1	0.1	12.6	12.4	16.0	5	70	1
BZX84C20T	P7	18.8	20	21.2	55	5	225	1	0.1	14	14.4	18.0	5	60	1
BZX84C22T	P8	20.8	22	23.3	55	5	225	1	0.1	15.4	16.4	20.0	5	60	0.6
BZX84C24T	P9	22.8	24	25.6	70	5	250	1	0.1	16.8	18.4	22.0	5	55	0.6
BZX84C27T	PA	25.1	27	28.9	80	2	250	0.5	0.1	18.9	21.4	25.3	2	50	0.6
BZX84C30T	PB	28	30	32	80	2	300	0.5	0.1	21.0	24.4	29.4	2	50	0.6
BZX84C33T	PC	31	33	35	80	2	300	0.5	0.1	23.1	27.4	33.4	2	45	0.6
BZX84C36T	PD	34	36	38	90	2	325	0.5	0.1	25.2	30.4	37.4	2	45	0.6
BZX84C39T	PE	37	39	41	130	2	350	0.5	0.1	27.3	33.4	41.2	2	45	0.6



# BZX84C2V4T THRU BZX84C39T

## ■ Characteristics (Typical)

**Fig 1: P<sub>D</sub>-T<sub>a</sub> Curve**

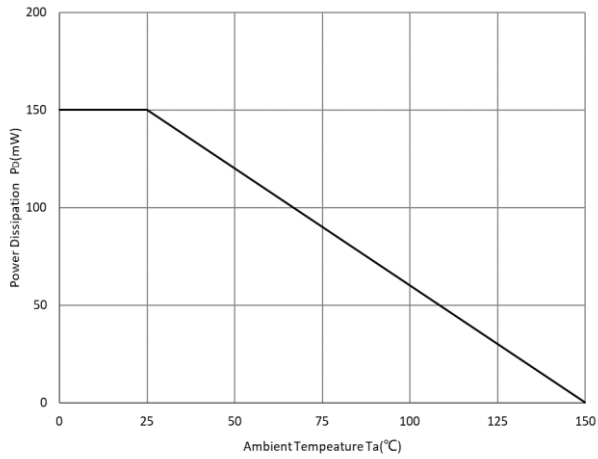

**Fig 2: Zener Breakdown Characteristics**

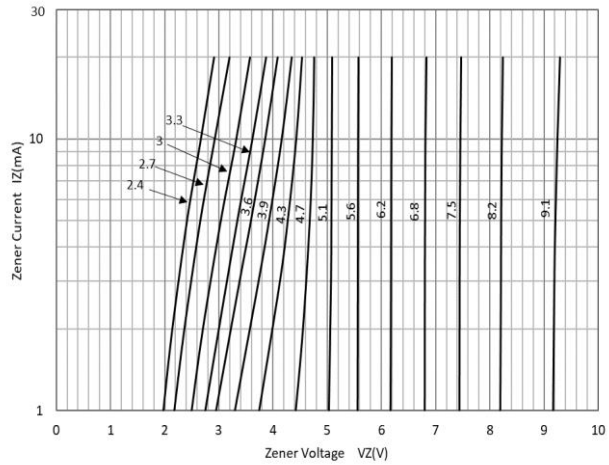

**Fig 3: Zener Breakdown Characteristics**

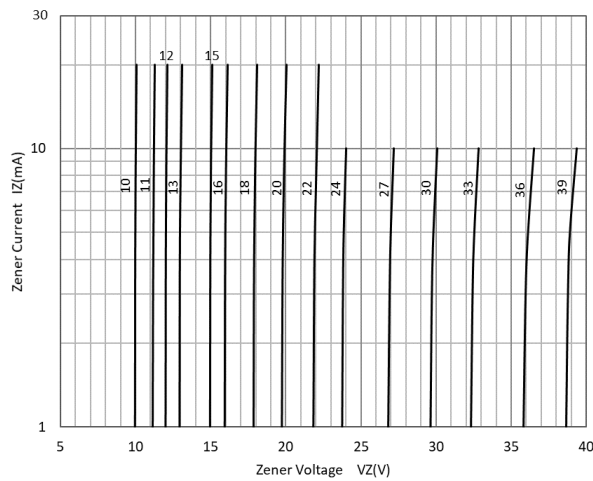

**Fig 4 Typical Temperature Coefficient**

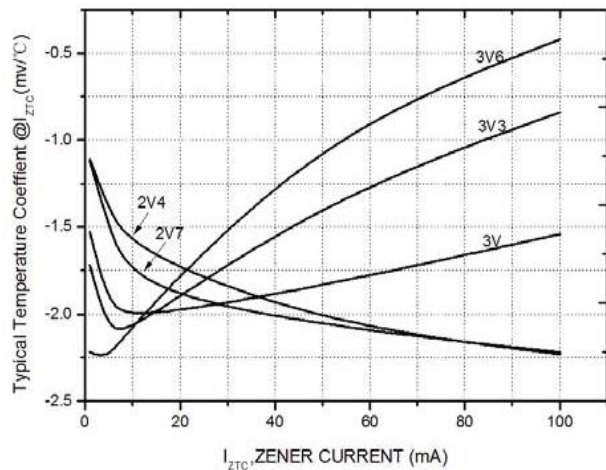

**Fig 5 Typical Temperature Coefficient**

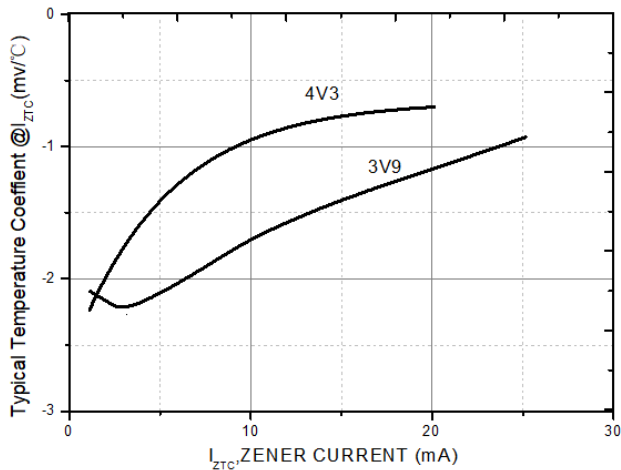

**Fig 6: Typical Temperature Coefficient**

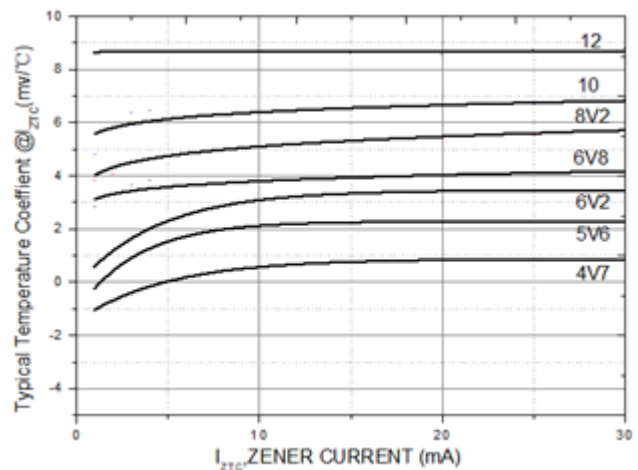



# BZX84C2V4T THRU BZX84C39T

**Fig 7 Typical Temperature Coefficient**

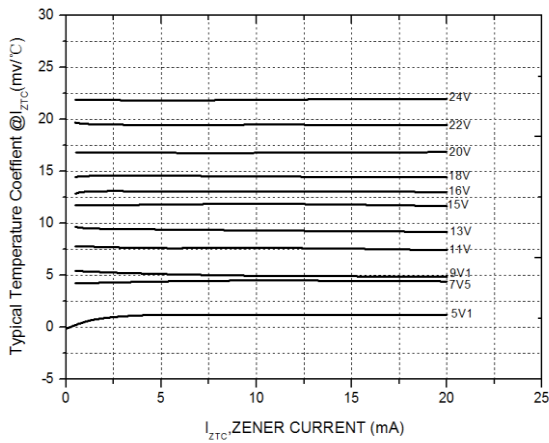

**Fig 8: Typical Temperature Coefficient**

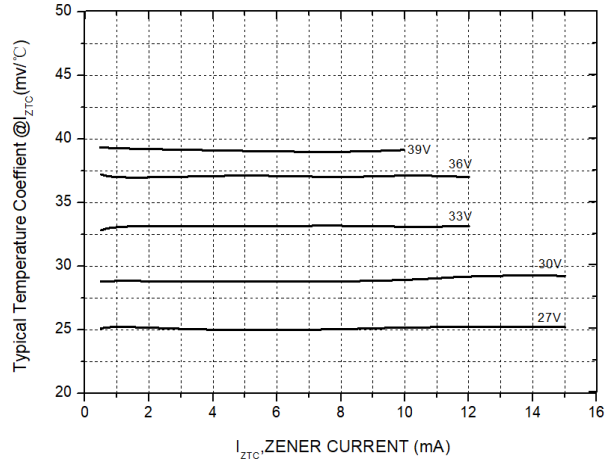

**Fig 9: Typical Forward Voltage**

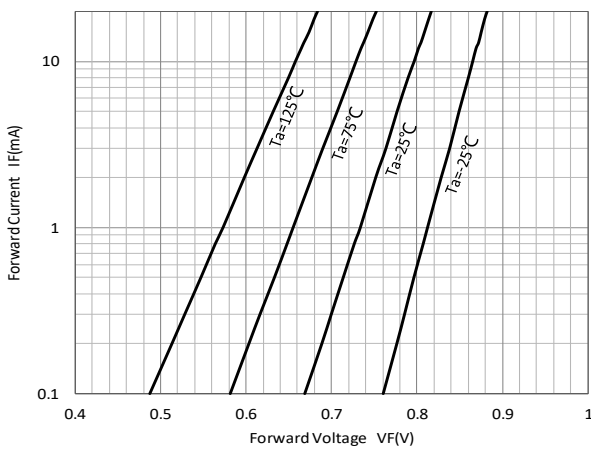

**Fig 10: Typical Reverse Current**

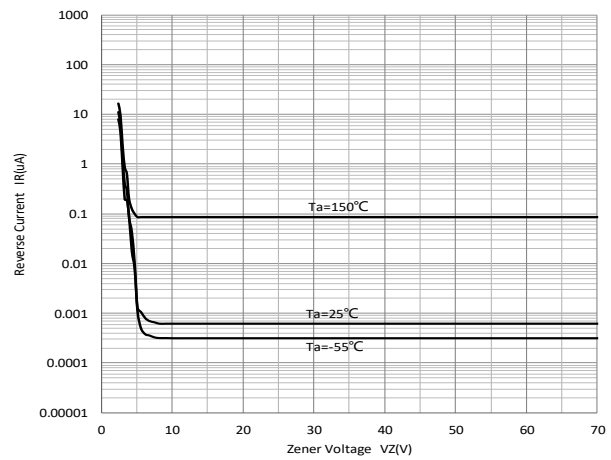

**Fig 11: Typical Capacitance**

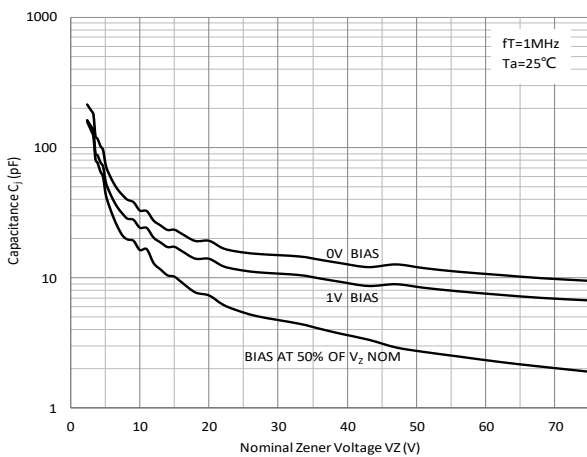



# BZX84C2V4T THRU BZX84C39T

## ■ SOT-523 Package Outline Dimensions

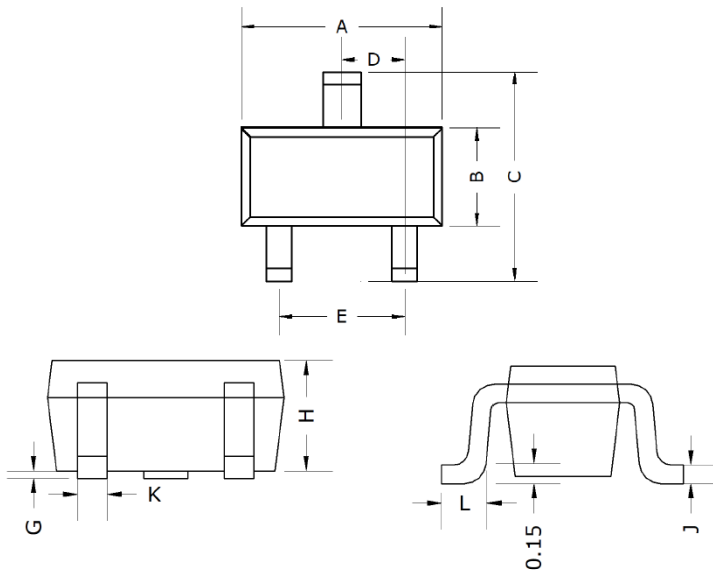

DIMENSIONS				
DIM	INCHES		MM	
	MIN	MAX	MIN	MAX
A	0.059	0.067	1.50	1.70
B	0.030	0.033	0.75	0.85
C	0.057	0.069	1.45	1.75
D	0.020TYP		0.50TYP	
E	0.035	0.043	0.90	1.10
G	0.000	0.004	0.00	0.10
H	0.024	0.031	0.60	0.80
J	0.004	0.008	0.10	0.20
K	0.006	0.014	0.15	0.35
L	0.010	0.018	0.26	0.46

## ■ SOT-523 Suggested Pad Layout

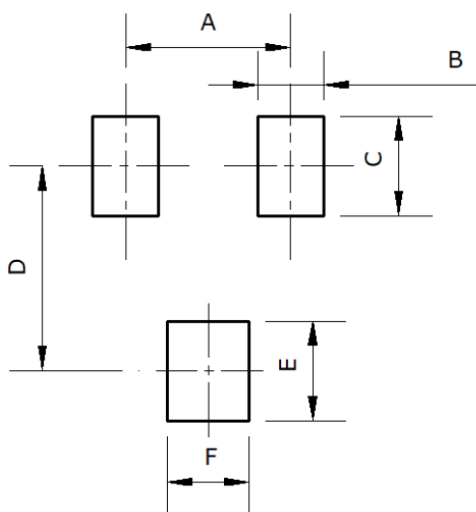

DIMENSIONS	
DIM	MM (TYP)
A	1.00
B	0.40
C	0.60
D	1.24
E	0.60
F	0.50



## BZX84C2V4T THRU BZX84C39T

---

### Disclaimer

The information presented in this document is for reference only. Yangzhou Yangjie Electronic Technology Co., Ltd. reserves the right to make changes without notice for the specification of the products displayed herein to improve reliability, function or design or otherwise.

The product listed herein is designed to be used with ordinary electronic equipment or devices, and not designed to be used with equipment or devices which require high level of reliability and the malfunction of which would directly endanger human life (such as medical instruments, transportation equipment, aerospace machinery, nuclear-reactor controllers, fuel controllers and other safety devices), Yangjie or anyone on its behalf, assumes no responsibility or liability for any damages resulting from such improper use of sale.

This publication supersedes & replaces all information previously supplied. For additional information, please visit our website [http:// www.21yangjie.com](http://www.21yangjie.com) , or consult your nearest Yangjie's sales office for further assistance.